

# Der Fachbereich Physik der Längenfeldschule

Verstehen wie die Welt funktioniert

# Magnetismus

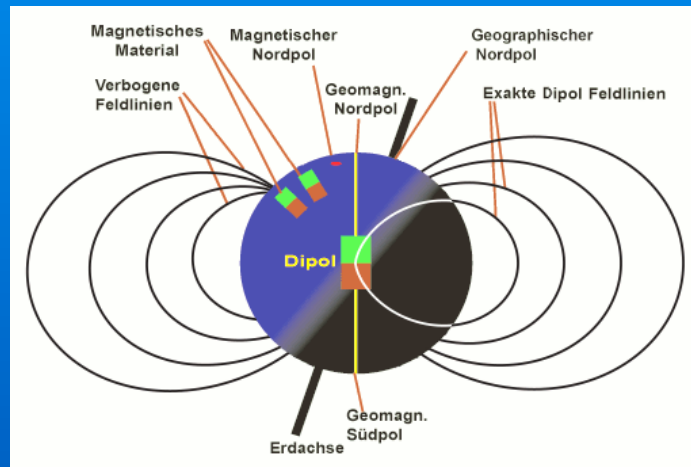
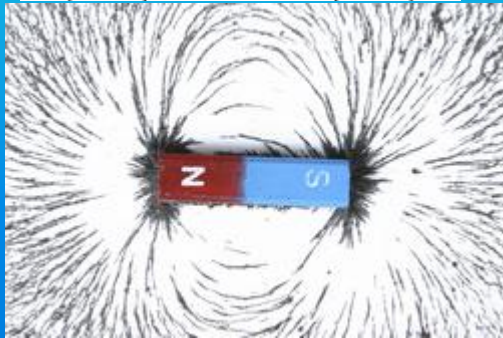
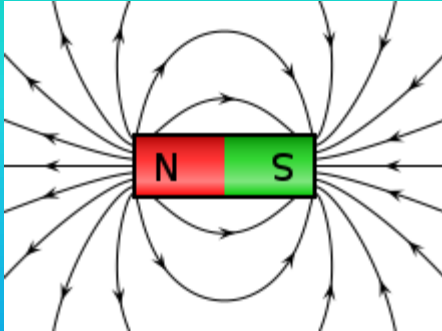

# Optik

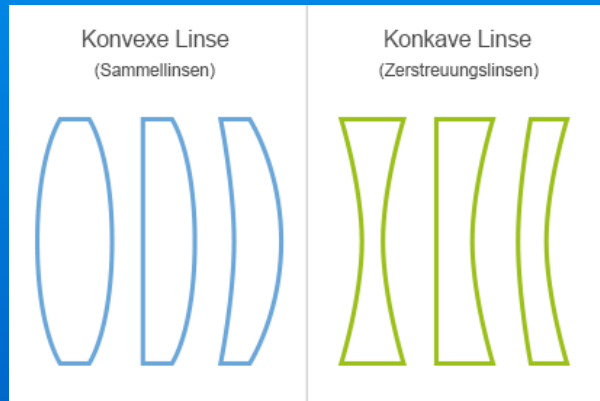
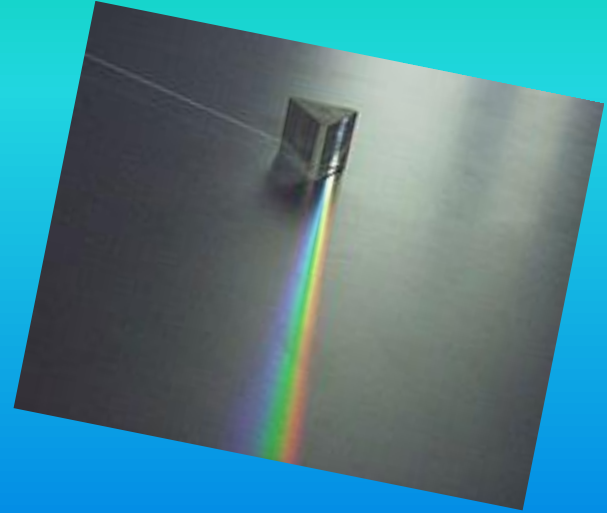
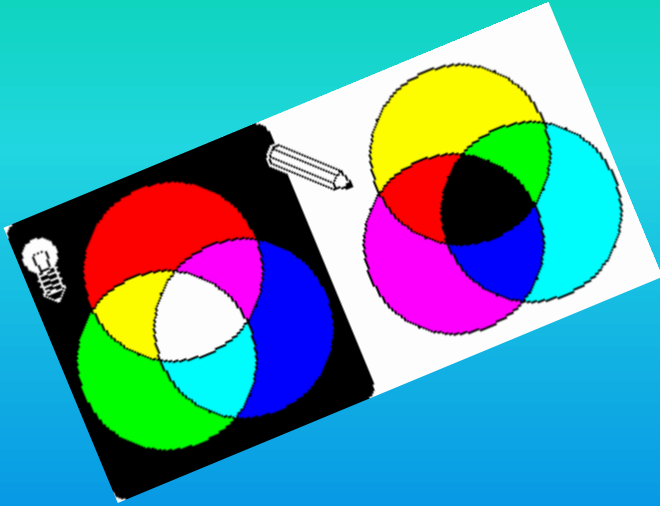

# Akustik

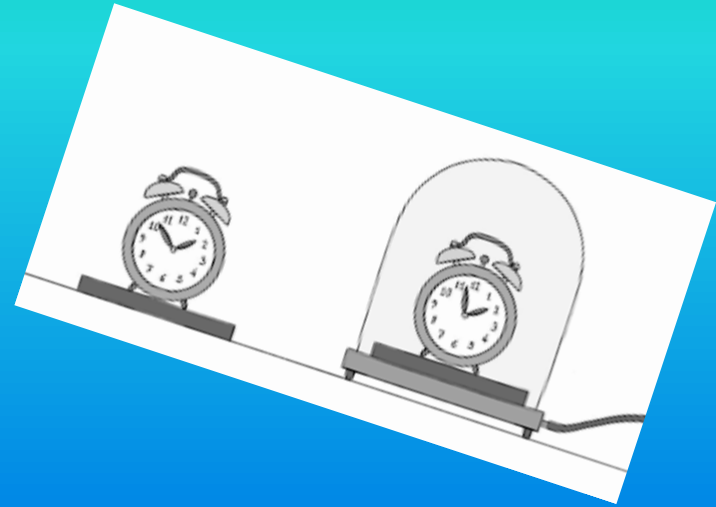
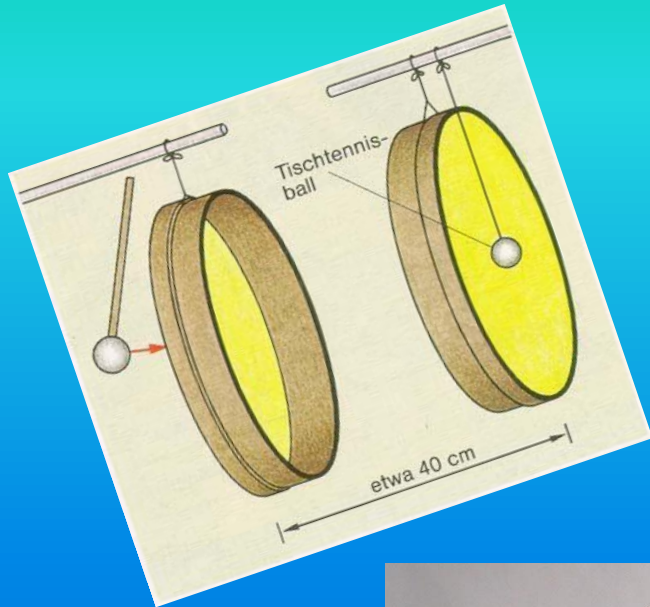

# Elektrik

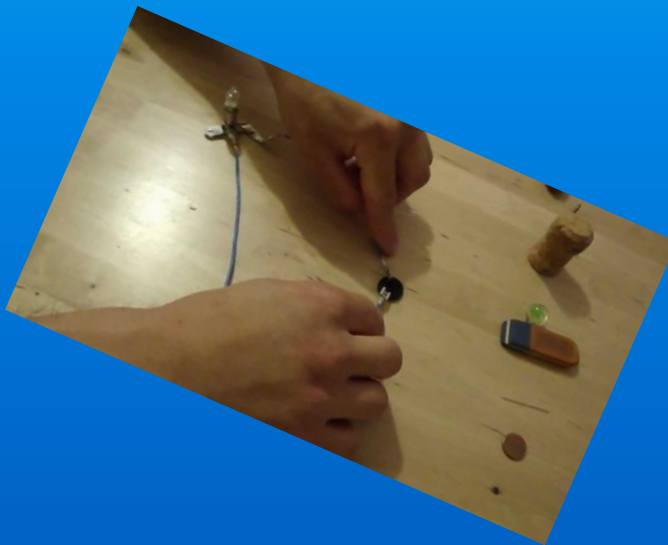
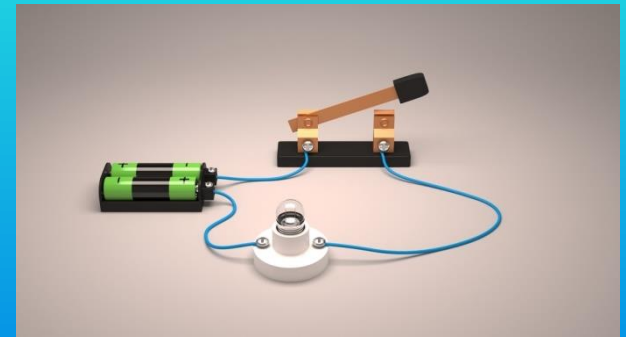
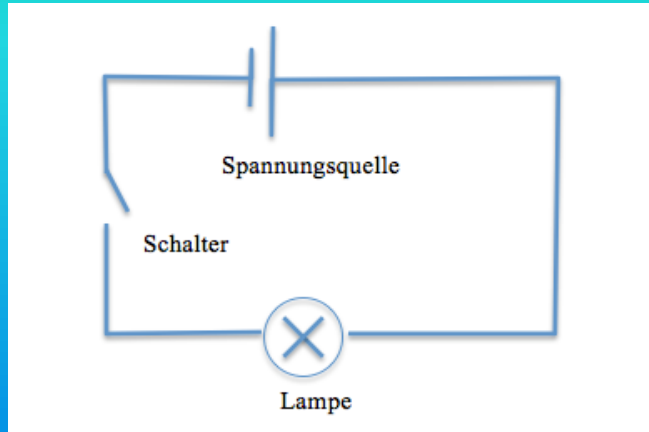

# Kinematik



$$\text{Geschwindigkeit} = \frac{\text{Weg}}{\text{Zeit}}$$



# Kräfte

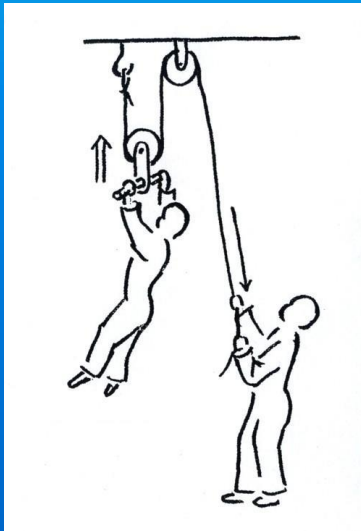
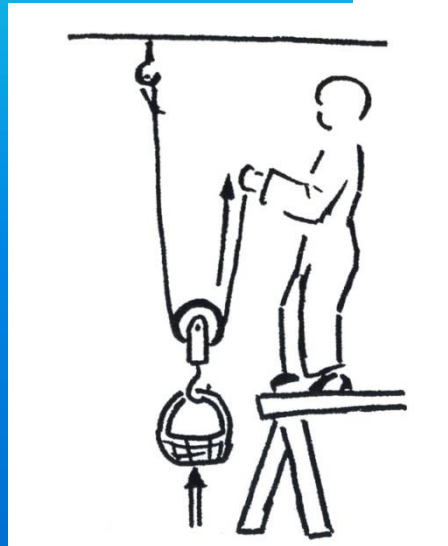
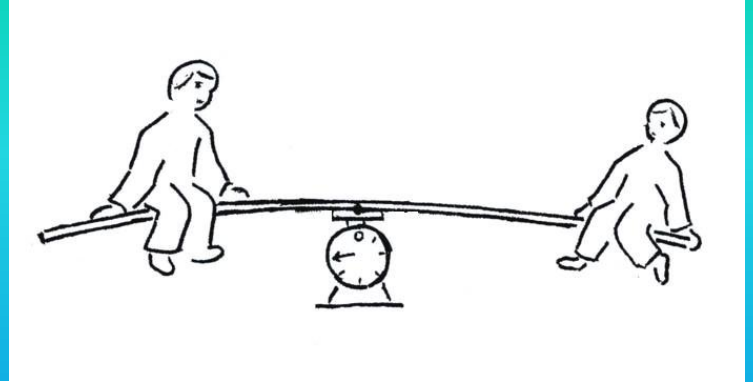
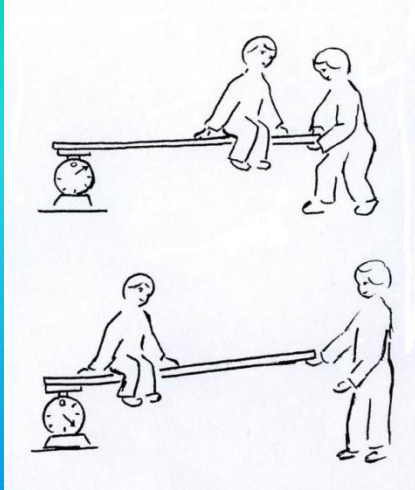



# Energie

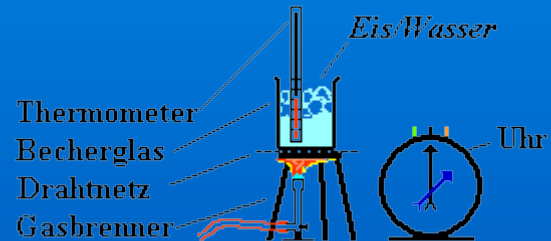
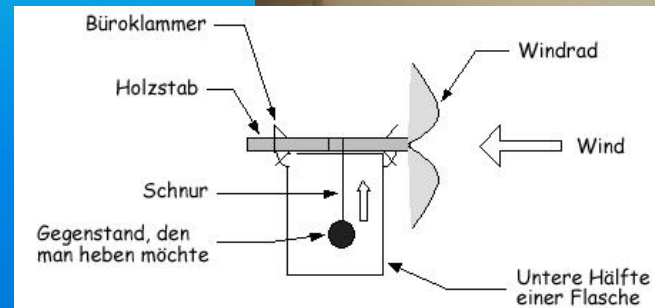
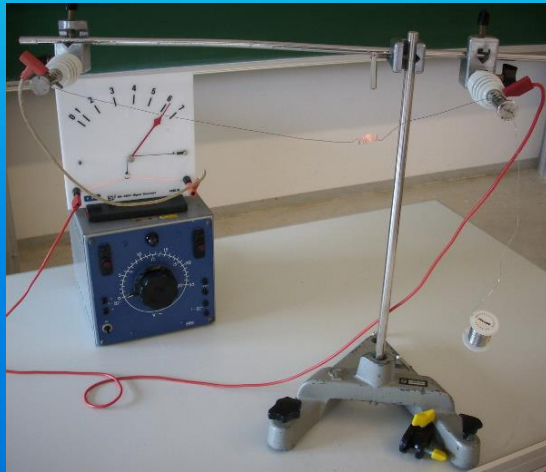
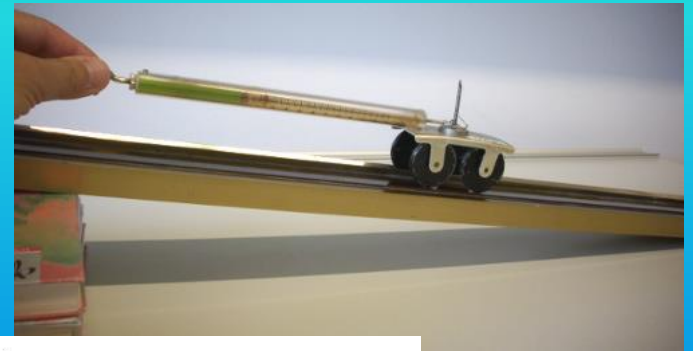
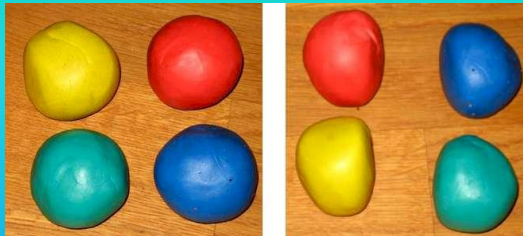



# Elektronik

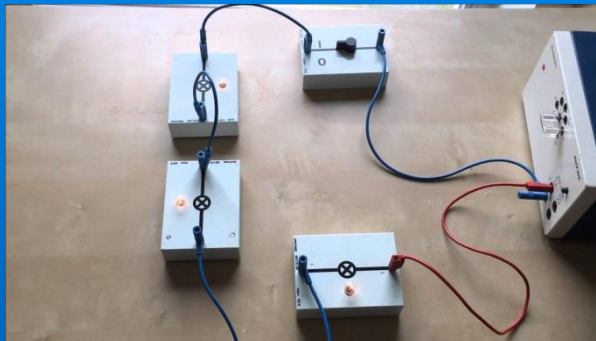
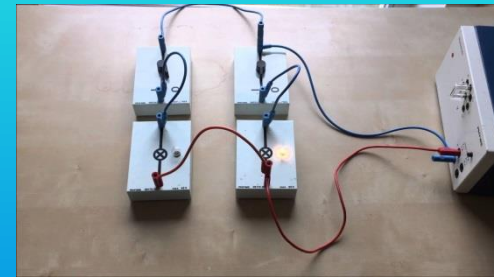
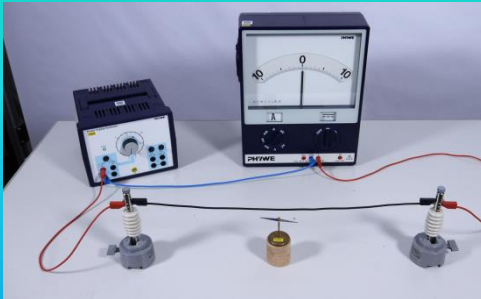

# Wärmelehre

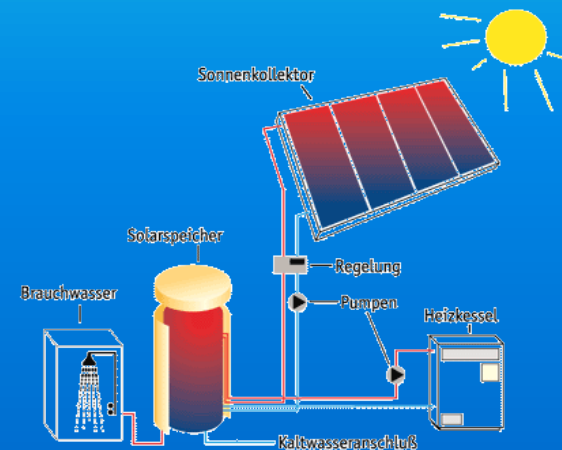
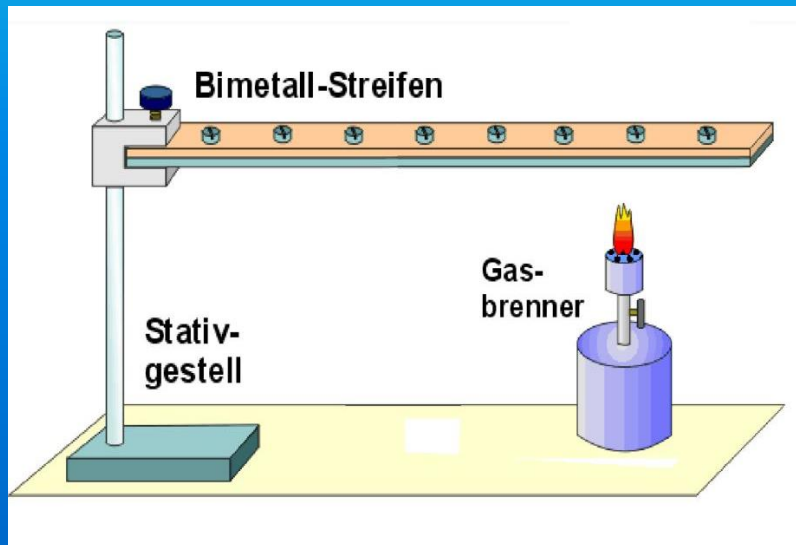
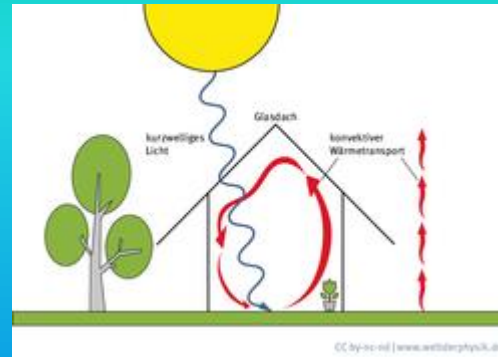
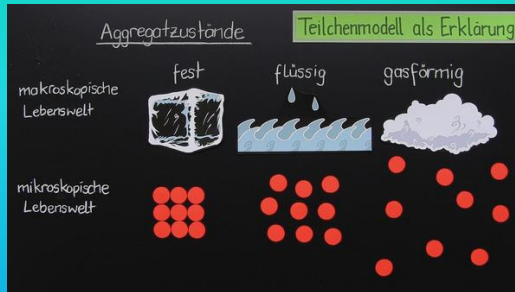

# Struktur der Materie

